

NAVY EXPERIMENTAL DIVING UNIT

REPORT NO. 11-96

EVALUATION OF THE U.S. DIVERS NORDIC SCUBA
REGULATOR FOR USE IN COLD WATER

J.R. CLARKE, D.L. JUNKER, and M. RAINONE

SEPTEMBER 1996

NAVY EXPERIMENTAL DIVING UNIT



~~RESTRICTED INFORMATION~~

DISTRIBUTION STATEMENT A

Approved for public release
Distribution Unlimited



DEPARTMENT OF THE NAVY
NAVY EXPERIMENTAL DIVING UNIT
321 BULLFINCH ROAD
PANAMA CITY, FLORIDA 32407-7015

IN REPLY REFER TO:

NAVSEA TA 96-010

NAVY EXPERIMENTAL DIVING UNIT

REPORT NO. 11-96

EVALUATION OF THE U.S. DIVERS NORDIC SCUBA
REGULATOR FOR USE IN COLD WATER

J.R. CLARKE, D.L. JUNKER, and M. RAINONE

SEPTEMBER 1996

DISTRIBUTION STATEMENT A: Approved for public release; distribution is unlimited.

Submitted:

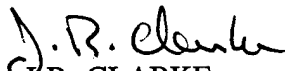

J.R. CLARKE
GM-15



D.L. JUNKER
MMCM(DV), USN

M. RAINONE
EN1(DV/SW), USN

Reviewed:

R.W. MAZZONE
LCDR, USN
Senior Projects Officer

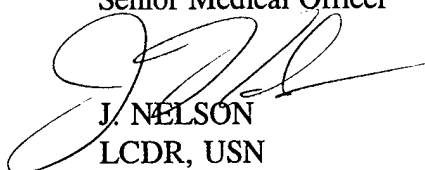
M. KNAFELE
CAPT, MC, USN
Senior Medical Officer

J. NELSON
LCDR, USN
Executive Officer

Approved:

J.R. WILKINS III
CDR, USN
Commanding Officer

19961113 167

REPORT DOCUMENTATION PAGE

1a. REPORT SECURITY CLASSIFICATION Unclassified		1b. RESTRICTIVE MARKINGS	
2a. SECURITY CLASSIFICATION AUTHORITY		3. DISTRIBUTION/AVAILABILITY OF REPORT DISTRIBUTION STATEMENT A: Approved for public release; distribution is unlimited	
2b. DECLASSIFICATION/DOWNGRADING AUTHORITY			
4. PERFORMING ORGANIZATION REPORT NUMBER(S) NEDU TR No. 11-96		5. MONITORING ORGANIZATION REPORT NUMBER(S)	
6a. NAME OF PERFORMING ORGANIZATION Navy Experimental Diving Unit	6b. OFFICE SYMBOL (If Applicable) 00D	7a. NAME OF MONITORING ORGANIZATION	
6c. ADDRESS (City, State, and ZIP Code) 321 Bullfinch Road, Panama City, FL 32407-7015		7b. ADDRESS (City, State, and Zip Code)	
8a. NAME OF FUNDING SPONSORING ORGANIZATION Naval Sea Systems Command	8b. OFFICE SYMBOL (If Applicable) 00C	9. PROCUREMENT INSTRUMENT IDENTIFICATION NUMBER	
8c. ADDRESS (City, State, and ZIP Code) 2531 Jefferson Davis Highway, Arlington, VA 22242-5160		10. SOURCE OF FUNDING NUMBERS	
		PROGRAM ELEMENT NO.	PROJECT NO.
		TASK NO. 96-010	WORK UNIT ACCESSION NO.
11. TITLE (Include Security Classification) (U) Evaluation of the U.S. Divers Nordic SCUBA Regulator for Use In Cold Water			
12. PERSONAL AUTHOR(S) J.R. Clarke, D.L. Junker, and M. Rainone			
13a. TYPE OF REPORT Technical Report	13b. TIME COVERED FROM JAN 95 TO JUN 96	14. DATE OF REPORT (Year, Month, Day) September 1996	15. PAGE COUNT 13
16. SUPPLEMENTARY NOTATION			
17. COSATI CODES			18. SUBJECT TERMS (Continue on reverse if necessary and identify by block number) SCUBA regulators, cold water, U.S. Divers, Nordic, work of breathing, resistive effort, hydraulic lock, mass flow, freeze-up susceptibility, probability
FIELD	GROUP	SUB-GROUP	
19. ABSTRACT (Continue on reverse if necessary and identify by block number) NEDU tested the breathing effort and susceptibility to freeze-up of the U.S. Divers Nordic SCUBA regulator. Five regulators were tested in 28°F (-2°C) salt water, at depths to 198 fsw (60.7 msw). The probability of regulator failure was computed from the number of cold induced incidents, and the time to failure for each incident. There were no freeze-ups of the first or second stages. However, resistive effort was remarkably high, especially at low bottle pressures. The first stage regulator frequently malfunctioned due to the loss of silicon oil. High breathing pressure events during the resistive effort measurements occurred at mass flow rates exceeding 300 g/min at a 1500 psi supply pressure. Due to leakage of silicone oil and high breathing effort at low bottle pressures, the U.S. Divers Nordic is not recommended for Navy use in cold water (28°F) at any depth.			
20. DISTRIBUTION/AVAILABILITY OF ABSTRACT <input type="checkbox"/> UNCLASSIFIED/UNLIMITED <input checked="" type="checkbox"/> SAME AS RPT. <input type="checkbox"/> DTIC USERS		21. ABSTRACT SECURITY CLASSIFICATION Unclassified	
22a. NAME OF RESPONSIBLE INDIVIDUAL NEDU Librarian	22b. TELEPHONE (Include Area Code) 904-230-3100	22c. OFFICE SYMBOL	

CONTENTS

GLOSSARY	iii
INTRODUCTION	1
METHODS	1
Regulators	1
Environmental Control.....	1
Breathing Simulator	2
Statistics.....	2
Freeze-Up Dive Profiles.....	2
Failure Probability Determination	2
Resistive Effort	3
RESULTS	3
First Stage Function	3
Freeze-Up Susceptibility.....	5
Resistive Effort	5
Event Incidence in Resistive Effort Tests	5
DISCUSSION	6
RECOMMENDATION	7
REFERENCES	8

ILLUSTRATIONS

<u>Figure No.</u>		<u>Page No.</u>
1	Intermediate pressure in two Nordic regulators	3
2	Consequence of hydraulic lock in a Nordic first stage	4
3	Nordic first stage regulator	4
4	Resistive effort at moderate (top panel) and low supply pressures	5
5	Incidence of high pressure events during resistive effort tests	6

GLOSSARY

ANU	Authorized for Navy Use List (NAVSEAINST 10560.2 series)
bar	Metric Unit of pressure conveniently sized for supply pressures. One bar = 100 kPa, or 14.5 psi.
cmH ₂ O	A metric expression of static pressure head. One cmH ₂ O = 0.01 meters of pure water. In pressure equivalents, 1 cmH ₂ O = 0.736 torr, 981.8 Pa, or 0.0982 kPa.
fsw	Feet of Seawater, a unit of pressure. One fsw = 0.3063 msw.
hydraulic lock	A failure of the first stage regulator to track ambient pressure due to blockage of pressure sensing ports.
J/L	Joules per liter, unit of measure for "Work of Breathing" normalized for tidal volume. One J/L = 1 kPa.
kPa	Kilopascals or newton/m ² , unit of pressure. One kPa ~ 10.2 cmH ₂ O
msw	Meters of Sea Water. One msw = 3.2646 fsw.
NAVSEA	Naval Sea Systems Command
NEDU	Navy Experimental Diving Unit
psi	Pounds per Square Inch, an English measure of pressure. One psi = 6.895 kPa. 1 bar = 14.504 psi.
\bar{P}_v	Volume averaged pressure, or resistive effort, otherwise known by the misnomer Work of Breathing (WOB). A computer derived estimate of total resistive respiratory effort obtained when breathing a regulator with a mechanical breathing simulator.
resistive effort	See above definition.
RMV	Respiratory Minute Volume with units of L·min ⁻¹

INTRODUCTION

The U.S. Navy has a requirement to identify open circuit SCUBA regulators which perform reliably in 28°F (-2°C) water and depths down to 190 fsw (58.2 msw). To this end, NEDU was tasked¹ to test and evaluate production models of commercially available, open circuit SCUBA regulators to determine those which best meet the U.S. Navy's requirement. This is a report on the U.S. Divers Nordic regulator.

The Nordic regulator is named for the Nordic first stage regulator which is a balanced flow-through piston first stage with a silicon filled ambient chamber. The second stage regulator is a relabeled Arctic second stage, and contains a heat exchanger to reduce the risk of second stage freeze-up.

For regulators designed for use in relatively warm water (>37°F), the primary criterion by which the regulators are judged during unmanned testing is their ability to meet the Performance Goal Standards² for volume-averaged pressure (\bar{P}_v) or resistive effort. For diving under polar ice, however, a more important consideration than breathing effort is resistance to freeze-up. In modern regulators, freeze-up is usually manifested as free-flow due to either a second stage failure, or first stage loss of intermediate pressure control. On rare occasions the first stage can fail with complete blockage of gas flow. Since freeze-up is a potentially life-threatening occurrence, we placed primary emphasis on regulator freeze-up susceptibility, with secondary emphasis on \bar{P}_v .

METHODS

Regulators

U.S. Divers (Santa Ana, Ca.) provided five samples of the Nordic regulator (Model No. 1077-80) for evaluation. Serial numbers were CA2102, CA2632, CA2691, CA2793, CA2795. They were set up according to U.S. Divers instructions and bench tested prior to the initial cold water exposures.

Environmental Control

The test regulators were submerged in brine-filled tanks with water temperature maintained at 28°F to 31°F (-2.2°C ± -0.5°C). The brine mixture was prepared with tap water and Instant Ocean[®] salt mixture (Aquarium Systems, Mentor, OH). The salinity of the brine solution was approximately 45 parts per thousand to prevent ice formation on the heat exchanger coils and loss of temperature control. Salinity was measured by the refractive index of the brine using an automatic temperature compensated hand refractometer (Model 10419, Reichert Scientific Instruments, Buffalo, NY). The water content in the high pressure air supply was measured by a phosphorous pentoxide (P₂O₅) detector system, and was found to be 23 ppm, translating to a -65.5°F dew point.

"Exhaled" air from the breathing machine was heated and humidified such that the gas temperature measured at the chrome tee (connected to the mouthpiece of the second stage regulator) ranged between 10° and 20°C. Under steady-state conditions, the exhaled temperature (T_{ex}) varied with depth, tending to be higher at the greater depths.

Breathing Simulator

A computer controlled electro-mechanical breathing simulator (Battelle, Columbus, OH) ventilated each regulator at respiratory minute volumes (RMV) ranging from 22.5 to 90 L·min⁻¹, thus emulating varied diver work rates. Supply pressure to the first stage was maintained at 1500 psi (103.4 bar) for one set of tests, then reduced to 500 psi (34.5 bar) for another set. This procedure was in accordance with NEDU Test Plan 93-21, except that in this instance the regulators were warmed and dried before repeating the cold water exposure with 500 psi supply pressure³. Recordings of pressure-volume loops were taken at 33 fsw (10 msw) increments. Test depths ranged from 0 to 198 fsw (0 to 60.7 msw). Testing at a specific RMV/depth parameter was terminated if inhalation or exhalation pressure exceeded 4 kPa, the working limits of the pressure transducers currently used in the Experimental Diving Facility.

Statistics

Descriptive statistics were used to obtain the mean and standard deviation of the resistive effort data. The one-sided, one sample T-test was used to compare test results with the NEDU performance goal for SCUBA regulators. Examples of the application of this test is described in Chapter 7 of the NEDU Technical Manual on Unmanned Test Methods and Performance Goals². Statistical significance was established at $P < 0.05$.

Freeze-Up Dive Profiles

NEDU routinely uses a fixed depth, worst case protocol for evaluating freeze-up susceptibility. This consists of diving the regulator to 198 fsw (60.7 msw) and breathing it at an RMV of 62.5 L·min⁻¹ for 30 minutes. This run is repeated at 132 fsw (40.4 msw) and 33 fsw (10.1 msw).

Failure Probability Determination

For freeze-up susceptibility tests, both the number of regulators freezing and the time at which they froze was considered. Those results were empirically combined in the following manner.

$$P_f = \sum_{i=1}^n \left(\frac{n^{-1} \cdot E_i}{t_i^k} \right) \quad (1)$$

where P_f is the probability of failure (ranging between 0 and 1), n is the number of regulators, E is a binary event equal to 0 if there is no failure and 1 if the regulator fails, t is the time to failure

in minutes, and k is an empirical constant = 0.3, chosen to provide reasonable probabilities. By NEDU convention, n = 5. If all 5 regulators freeze after 1 minute, then

$$P_f = \left(\frac{0.2 \cdot 1}{1^{0.3}} + \frac{0.2 \cdot 1}{1^{0.3}} + \frac{0.2 \cdot 1}{1^{0.3}} + \frac{0.2 \cdot 1}{1^{0.3}} + \frac{0.2 \cdot 1}{1^{0.3}} \right) = 1.0$$

If no regulators fail, then $P_f = 0$. If 2 freeze, one at 18 minutes and one at 28 minutes, then $P_f = 0.158$. When ranking the desirability of various cold water regulators, a regulator with a P_f of 0.158 would be preferred over one with a P_f of 0.34.

$$P_f = (0 + 0 + 0 + \frac{0.2 \cdot 1}{18^{0.3}} + \frac{0.2 \cdot 1}{28^{0.3}}) = 0.158$$

The above empirical probability estimation is nothing more than a way of quantitatively comparing, or of ranking, various regulators. It does not estimate the actual probability of freeze-ups during an open water dive. That probability is dependent upon the duration of the dive relative to the expected time of regulator freeze-up.

Resistive Effort

\bar{P}_v levels are a computer derived estimate of total respiratory effort obtained when breathing a regulator with a mechanical breathing simulator, measured in kPa (or in more cumbersome terms, joules per liter, J/L). \bar{P}_v averages were derived from the mean of tests on up to five individual regulators for each model.

RESULTS

First Stage Function

Early in testing, the Nordic regulator suffered a number of first stage hydraulic locks which prevented the first stage from tracking chamber pressure. Symptoms were either unusually high intermediate pressures, or a large drop in intermediate pressure with increasing depth.

Figure 1 shows intermediate pressure tracings from two regulators being tested simultaneously. The regulator in the top tracing returned at the end of each inhalation to a high intermediate pressure of about 195 psi. The bottom tracing shows the second regulator returning intermediate pressure (i.p.) to the expected 135 psi.

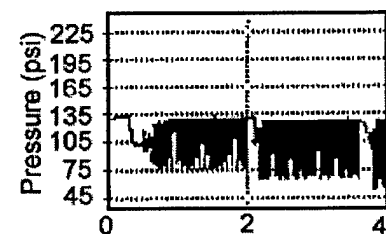
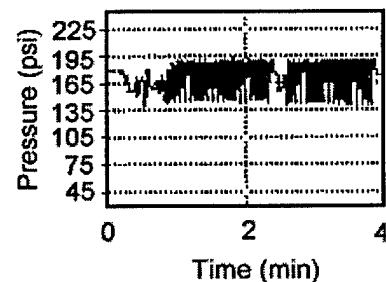

Figure 1. Intermediate pressure in two Nordic regulators.

The large drop in intermediate pressure with increasing depth is shown in Fig. 2. The response of the regulator was due to a leakage of silicone oil from the first stage, allowing the secondary diaphragm to seal the orifice leading to the ambient pressure chamber (Fig. 3). During descent with low pressure locked into the ambient chamber, intermediate pressure was maintained at an abnormally low value. The result for the diver would be a grossly increased resistive breathing effort.

While regulators with hydraulic locks are on the bottom, air may leak from the high pressure side of the first stage into the ambient chamber, thus increasing intermediate pressure as in Fig. 1. This leakage is probably due to the effect of cold on the o-ring sealing the high pressure chamber from the ambient chamber. Such leakage typically corrected the high resistive effort. However, on ascent, the build up of high pressure within the "ambient pressure" chamber tended to invert the secondary "sensor" diaphragm, and in some cases tear it by forcing the diaphragm through the orifice connecting to ambient sea water.

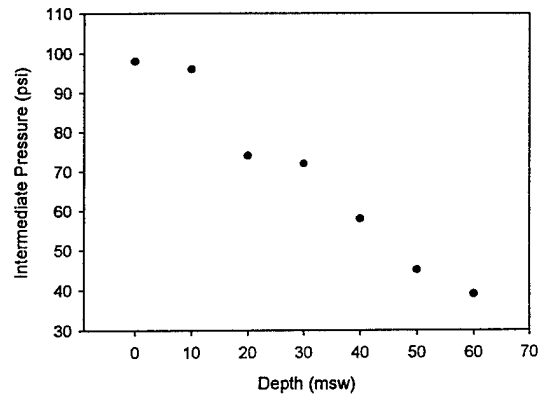

Figure 2. Consequence of hydraulic lock in a Nordic first stage.

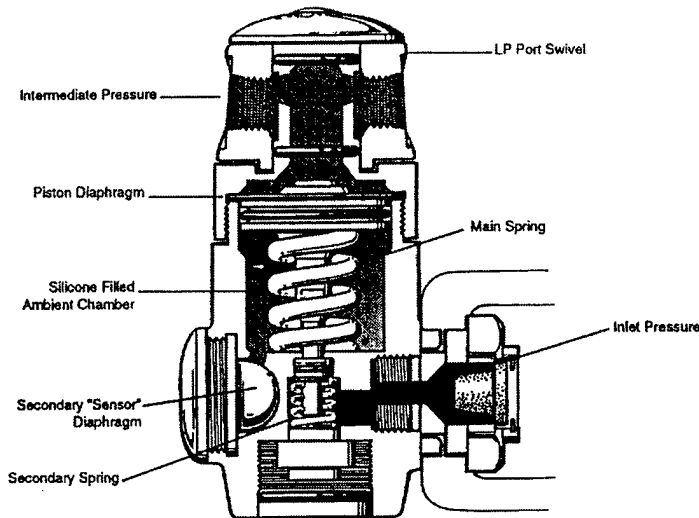

Figure 3. Nordic First Stage Regulator.

After the cause of these problems was discovered, each regulator had its oil reservoir filled to overflowing before each run. As long as this unusual maintenance procedure was followed, no further problems developed.

Freeze-up Susceptibility

After maintenance procedures were conducted as described above, all five Nordic regulators completed the entire thirty minute susceptibility test with no difficulty. From Equation (1) the P_f for the Nordic regulators was 0.0.

Resistive Effort Determination

The mean resistive efforts for the Nordic regulators at 1500 psi (103.4 bar) and 500 psi (34.5 bar) supply pressure are shown in Figure 4. The horizontal lines in each panel represent the NEDU performance goal² for SCUBA regulators, 1.37 kPa. The majority of the runs at the low supply pressure were aborted by the operators to protect the test instrumentation whenever the inhalation or exhalation pressures exceeded 4 kPa. The plotted means represent the average for all runs that were completed by all 5 regulators. Typically, the \bar{P}_v of greatest interest is that at an RMV of 62.5 L·min⁻¹ (upward pointing triangles) at the deepest depth. At low bottle pressure (500 psi, 34.5 bar) resistive effort was immeasurably high deeper than 33 fsw (10 msw).

Event Incidence in Resistive Effort Tests

The primary purpose of resistive effort measurements was to describe the breathing effort of the regulators. However, two events could hamper those measurements; one is excessively high ventilatory pressures, and the other is regulator free flow. The two events are considered of equal importance since both could be due to the effects of cold water.

Figure 5 is a plot of the dependent variable, event incidence with a 1500 psi (103.4 bar) supply pressure, against the independent variables mass flow rate and test sequence. The independent variables are located on the horizontal plane. The test sequence represents the order

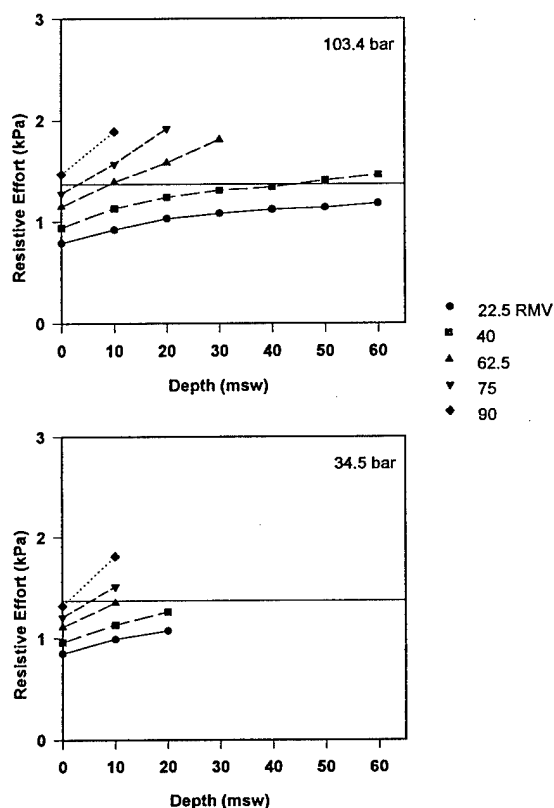

Figure 4. Resistive effort at moderate (top panel) and low supply pressures.

in which tests were conducted on each regulator. Each test began at 190 fsw with an RMV of 22.5 L·min⁻¹. RMVs were increased sequentially through 90 L·min⁻¹, and then the chamber was brought up to the next shallower depth before the RMVs were repeated. Consequently, tests at the surface and 90 L·min⁻¹ were the last runs conducted. For both regulators, the entire test sequence took between 1 hr and 1 hr 15 min. Therefore, each sequence number represents an interval of about 2 min.

Mass flow, with units of grams per min (g/min), is shown on the second horizontal axis. Mass flow is defined as:

$$\dot{M} = \rho \cdot RMV \cdot \frac{P_{amb}}{P_0}$$

where ρ is gas density in g/L at 1 atm absolute and 0° C, RMV is ventilation in L·min⁻¹, and P_{amb} is ambient pressure in absolute units. P_0 is the absolute pressure at 1 atm, a factor required to generate a dimensionless pressure ratio. Mass flow rate reflects the mass of gas flowing through the regulator each minute.

Up to a mass flow of 300 g/min, incidents of high resistive effort were nonexistent in the Nordic regulators, except for the longest cold exposures. Incidents increased almost linearly over the mass flow range from 300 to 600 g/min.

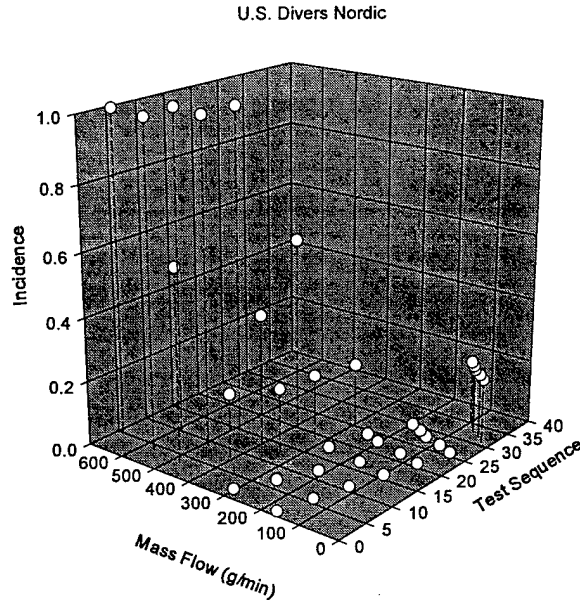

Figure 5. Incidence of high pressure events during resistive effort tests at 1500 psi supply pressure.

DISCUSSION

When the U.S. Divers Nordic regulator is serviced prior to each cold water dive, it performed well during a freeze-up susceptibility test that is admittedly far more severe than would probably be seen in actual diving. Unfortunately, when bottle pressure is as low as 500 psi, breathing effort exceeds 4 kPa, even in regulators that have been serviced just prior to the dive.

NEDU considers the pre-dive maintenance requirements to be unusually burdensome. The consequence of not topping off the first stage regulator with silicone oil is a hydraulic lock which causes grossly elevated inspiratory pressures during descent. The likely result would be, at the very least, an aborted dive.

RECOMMENDATION

On the basis of the high resistive effort at 500 psi bottle pressure, and the required pre-dive maintenance, the U.S. Divers Nordic regulator is not recommended for Navy use in cold water.

REFERENCES

1. Naval Sea Systems Command, *Commercial Diving Equipment Test and Evaluation*, Task 96-010, 4 Jan 96.
2. Navy Experimental Diving Unit, *U.S. Navy Unmanned Test Methods and Performance Goals for Underwater Breathing Apparatus*, NEDU TECH MAN 01-94, June 1994.
3. *Evaluation of Commercial Open Circuit Scuba Regulators (Unmanned/Manned)*. NEDU TP 93-21 (Limited Distribution), Navy Experimental Diving Unit, May 1993.